

# H07 Door Stop

Install  
Instructions

Bankston  
Civilian

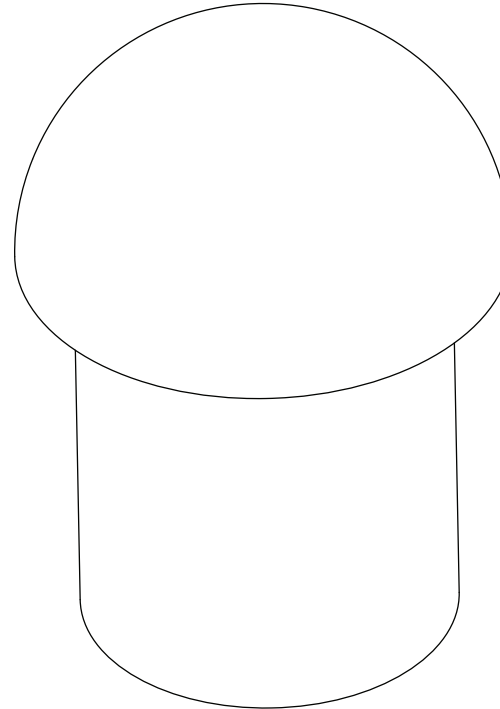

Finishes &  
Materials



FAQs &  
Warranty



Resources

COMPCV428



bankston.com  
@bankston\_architectural



**Bankston Australia**  
14-16 Stepney Street  
Stepney, South Australia 5069

P. +61 (0)8 8362 1133  
E. info@bankstonarchitectural.com.au

**Bankston New Zealand**  
P. +64 (0)6 359 0008  
E. info@bankstonarchitectural.co.nz

**Bankston International**  
E. info@bankston.com

**SDG Trading Pty Ltd trading  
as Bankston Architectural**  
ACN 008 154 041  
ABN 18 008 154 041

\*Image used for illustration  
purposes only

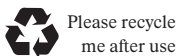

1. Remove the rubber stopper (A) from the mounting base (B). Figure 1.

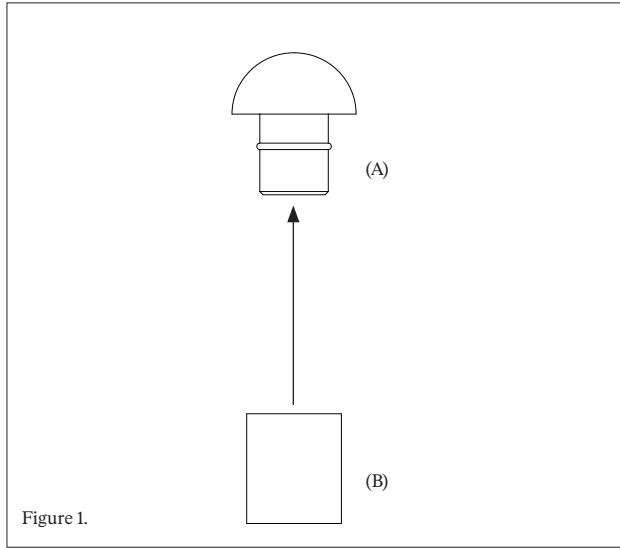

2. With the door closed mark a line on the floor away from the skirting board that is the same distance your door furniture protrudes from the door. Figure 2. Then carefully open the door and mark the touch point of the door to the wall. Figure 3. Extend this line out from the wall until it crosses the first line, this is the fixing position.

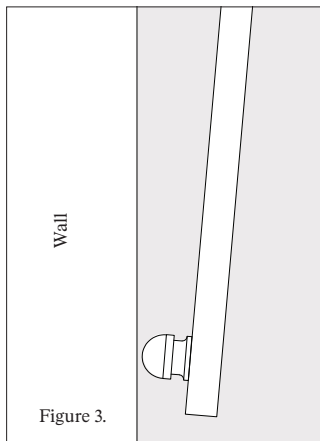
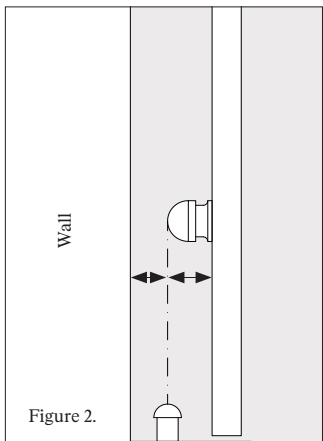

3. Alternatively, you can mount the door stop to the wall at the same height as your door furniture. Figure 4.

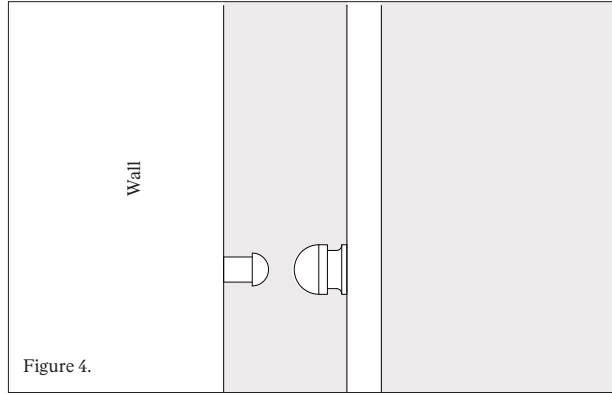

4. For fixing into timber floors using the stainless steel screw (C), drill a pilot hole to a depth of 30mm or 1 3/16" with your appropriate size drill bit.
5. For fixing to concrete floors drill a hole using a 5mm or 1 3/16" masonry bit to take the wall plug (D).
6. Place the screw (C) through the mounting base (B) and fix to the floor. Figure 5.

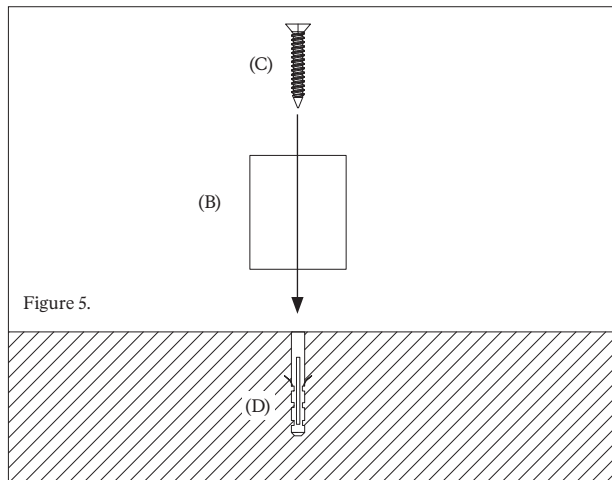

7. Place the rubber stopper (A) back over the mounting base (B). The ridge on the side of rubber stopper (A) should lock into the cavity of the mounting base (B). Figure 6.

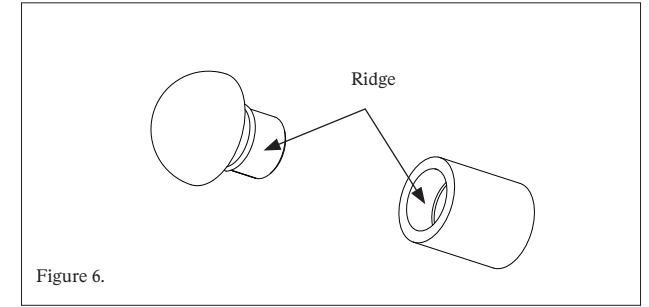

**Included:**

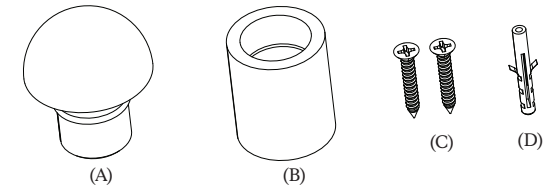

Included: (A) Rubber stopper x 1, (B) Mounting base x 1, (C) Stainless steel screw x 2, (D) Wall plug x 1

**PLEASE NOTE:**

Please note that screws require pre-drilling.  
Please take extra care when fitting.

**IMPORTANT:**

Please install this hardware in the following order to ensure its warranty is not voided.

1. Install the hardware on raw/unfinished door using the instructions provided.
2. Remove hardware (where possible) and store safely. Do not place tape onto the hardware as this will damage the finish.
3. Paint / finish door.
4. Reinstall hardware.